

Mini Environmental Quality Meter

850027

SPER
SCIENTIFIC

Environmental Measurement Instruments

Mini Environmental Quality Meter 850027

Copyright ©2012 by
Sper Scientific
ALL RIGHTS RESERVED
Printed in the USA

The contents of this manual may not be reproduced or transmitted in any form or by any means electronic, mechanical, or other means that do not yet exist or may be developed, including photocopying, recording, or any information storage and retrieval system without the express permission from Sper Scientific.

INTRODUCTION

For environmental testing anywhere. Model 850027 combines 11 environmental test functions into a single compact unit. Features include touch-tone buttons, min/max and hold functions. Comes ready to use with wrist strap, instructions, battery and soft carrying case.

MATERIALS SUPPLIED

Meter
Wristlet
CR 2032 DC 3V Battery
Soft Carrying Case

Optional Accessory:
850027P - Pt 1000
Temp. Probe

TABLE OF CONTENTS

1. INTRODUCTION	2
2. MATERIALS SUPPLIED.	2
3. FEATURES	4
4. FRONT PANEL DESCRIPTION	5
5. OPERATING INSTRUCTIONS	6
Power on/off	6
LCD backlight on/off.	6
Mode selection	6
Unit selection	6
Special attention for the	
Humidity measurement	8
Air flow measurement	9
Barometric measurement	10
Altitude measurement	11
Optional Pt 1000 probe	13
Hold Function	13
REC (Record) function	13
Auto power off disable.	14
6. BATTERY REPLACEMENT	14
7. SPECIFICATIONS.	15
8. WARRANTY	20

FEATURES

- 11 professional environmental instruments in 1
- Lightweight, ergonomic design
- Wristlet design provides extra protection to the instrument
- Low-friction ball bearing mounted impeller design provides high accuracy at high and low air velocity
- High precision humidity sensor with fast response time
- Barometric sensor for precise atmosphere and altitude measurement
- Built-in microprocessor circuit assures excellent performance and accuracy
- Optional Pt 1000 Temp. probe
- Concise and compact buttons arrangement for easy operation.
- Maximum and minimum memory with recall
- Hold function
- °C/°F selection

FRONT PANEL DESCRIPTION

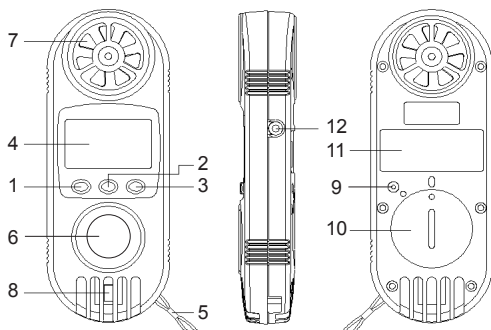

- 1 **HOLD** button
- 2 **⏻** Button (Power button)
- 3 **REC** button
- 4 LCD display
- 5 Wristlet
- 6 Light sensor
- 7 Anemometer vane
- 8 Humidity/Temperature sensor
- 8 Barometer sensor
- 10 Battery compartment cover
- 11 Buttons operation label
- 12 Pt 1000 ohm probe socket

OPERATING INSTRUCTIONS

Power on/off

⏻ Button = Power Button

1. Power on: Press ⏻ once to turn meter on.
2. Power off: Press ⏻ for > 3 seconds to turn meter off.

LCD backlight on/off

With the meter on, press ⏻ once. The LCD backlight will light for 5 seconds, then shut off automatically.

Mode selection

This meter offers 11 selectable modes:

- a. Anemometer (Air velocity) /Temp
- b. Air flow (CMM, CFM)
- c. Wind Chill
- d. Humidity/Temp
- e. Dew point Temp
- f. Wet bulb Temp
- g. Heat index
- h. Light
- i. Barometric pressure
- j. Altitude
- k. Pt 1000 Temp. (optional)

With the meter on, press **HOLD** continuously and the Display will show the following texts in sequence:

Display Mode text

An = Anemometer (Air velocity) /Temp

AirFL = Air flow (CMM, CFM)

CHILL = Wind chill

rH = Humidity/Temp

dP = Dew point Temp

_Et = Wet bulb Temp

HEAt = Heat index

LigHt = Light

bAr = Barometric pressure

High = Altitude

Pt = Pt 1000 Temp. (optional)

When the display shows the desired mode, release **HOLD** and the meter will set this mode as the default.

Anemometer (Air Velocity)/Temp Measurement

Unit Selection

REC button = Enter button

1. With the power on, press **REC** for >3 seconds, the display will show Unit. Release **REC**, then press **⏻** to scroll through the available scales. After the desired scale is selected, press **REC** to save as the default.

2. The next screen displays “dCdF” with the current temperature scale selection (°C or °F). Press **⏻** to select the desired scale. Press **REC** to save as the default.

Note...

When CHiLL, rH, dP, _Et and HEAt are the selected mode, you may only change the temperature scale setting. (°C or °F)

The selection scales for all modes are:

Measurement	Scales
Air Velocity	m/s, Km/h, mph, knot, FPM
Temp. (Air velocity)	°C/°F
Air flow	CMM, CFM
Wind chill	°C/°F
Temp. (Humidity)	°C/°F
Dew point	°C/°F
Wet bulb Temp.	°C/°F
Heat index	°C/°F
Light	Lux, FC
Barometric Pressure	hPa, mmHG, inHG
Altitude	m, ft
Pt 1000 Temp.	°C/°F

Air flow measurement



1. With the Power on, select Air flow mode (refer to page 7)
2. Set the measurement area dimension: Press **HOLD** once, the display will show Hold then press **REC** continuously until the lower left of the Display shows m-2 or F-2

m-2 = meter square

F-2 = ft square

The unit of measure is determined by the selected scale CMM or CFM

3. Use **HOLD** and  to adjust the air flow dimension value. When the desired dimension value is set, press **REC** to save as the default.

 button =  button

HOLD button =  button

REC button = Enter button

Note...

For the most accurate reading for the humidity/ Temp., Dew point Temp., Wet bulb Temp., Heat index measurement, do not touch or block the humidity sensor at any time with your hand.

Light measurement

For light measurement, hold the meter with the light sensor on top, so it is not blocked by your hand. The display will automatically reverse direction to be easily read.

Barometric pressure measurement

1. Actual location air pressure (absolute air pressure value) measurement: with Power on, select “Barometric pressure measurement” (refer to page 7, display will show bAr text), now the meter is ready for actual air pressure measurement (absolute air pressure value).



Note...

Actual air pressure in the measurement location changes in response to two things: changes in altitude and changes in atmosphere.

2. Sea level barometric pressure value measurement.
Press **HOLD** once, the Display will show the Hold indicator then press **REC** continuously until the bottom left of the display shows “m” or “ft”.

m = meter ft = feet

Use **HOLD** and  to adjust the location altitude value. When the location altitude value is set, pressing **REC** will show the sea level barometric pressure value.

 button =  button

HOLD button =  button

REC button = Enter button

Note...

The sea level barometric pressure value can not be saved as a default when the meter is powered off. When the meter is powered on again and bAr is selected the meter will show the actual air pressure in the measurement location (absolute air pressure value).

Altitude measurement

Note...

The higher the location altitude, in comparison to sea level, the lower the barometric pressure.

To measure your altitude value precisely:

- a. Method 1: Set the altitude value if your start location is known.
- b. Method 2: Reset the sea level barometric pressure value first.

Method 1:

Power on the meter and under the altitude function, press **HOLD** once, the display will show the Hold indicator. Press **REC** once, the bottom of the display will show the m (or Ft) indicator flashing.

Using **HOLD** and **⏻** adjust the altitude value. When the desired start location altitude value is set, press **REC** to save the setting value as the default.

⏻ button = **▲** button

HOLD button = **▼** button

REC button = Enter button

Note....

You can obtain your altitude value from a topographical map or local landmark. Google Earth is an excellent free program that provides the exact altitude for a given address: www.earth.google.com. You can also get the reference altitude value from the reading of a GPS system.

Method 2:

Power on the meter and under the altitude function, press **HOLD** once, the display will show the Hold indicator. Press **REC** continuously until the bottom left of display shows “HPA” indicator flashing. Release **REC**.

Use **HOLD** and the **⏻** to adjust the current sea level barometric pressure value. When the desired value is set, press **REC** to save as the default.

⏻ button = **▲** button

HOLD button = **▼** button

REC button = Enter button

Note...

You can obtain your current sea level barometric pressure value by checking an internet weather site for a nearby location or contacting a local airport.

Optional Pt 1000 Temp. measurement

1. Insert the plug of the optional Pt 1000 Temp. probe 850027P into the Pt 1000 probe socket (see page 5)
2. Power on the meter, select the function to “Pt 1000 Temp.” (refer to page 6), now the meter is ready for Pt 1000 Temp. measurement.

Hold Function

Pressing **HOLD** will freeze the current reading on the display. The Hold symbol will be displayed at the top of the display window.

To release the Hold function, press **HOLD** again, the Hold indicator will disappear and the current reading will be displayed.

REC (Record) function

The **REC** (Record) function will record and display the maximum and minimum readings.

1. Start the Record function by pressing **REC** once. The REC symbol will appear on the display.

2. With the REC symbol on the display:

- a. Press **REC** once and the Max symbol will appear on the display along with the current maximum value.
- b. Press **REC** again, the MIN symbol will appear on the display along with the current minimum value.
- c. Clear the recorded MAX or MIN value from the display by pressing **HOLD** once. The MAX/MIN symbols and their readings, will disappear from the display. The meter will return to the REC function and continue recording.
- d. To exit REC function press **REC** button for >2 seconds.

Auto power off disable

In order to prolong the battery life, this instrument has an Auto Power Off function: the meter will turn off if no buttons are pressed for approximately 10 minutes.

To disable the Auto Power Off function, press **REC** and enter the record function (page 13). The Auto power off function will be disabled until the record function is exited.

REPLACE BATTERY

1. When the LCD display shows  symbol, it is time to replace the battery. (Measurements may still be made for several hours after the low battery indicator appears.)
2. Open the Battery Compartment and remove the battery.
3. Install the battery (CR2032) and replace the cover.

GENERAL SPECIFICATIONS

Display	8 mm LCD display
Measurement	1. Anemometer (Air velocity)/Temp 2. Humidity/Temp 3. Light 4. Barometer 5. CFM, CMM 6. Dew point 7. Wet bulb 8. Wind chill 9. Heat index 10. Altitude 11. Pt 1000 Temp. (opt.)
Operating Humidity	Max. 80% RH
Operating Temp.	0 ~ 50°C (32 ~ 122°F)
Over Input Display	"- - - -"
Power Supply	CR 2032 DC 3V battery
Power Consumption	Approx. DC 5 mA
Weight	160g (battery included)
Dim (HWD)	4.7" x 1.8" x 1.2" (120 x 45 x 20 mm)
Standard Accessories	Instruction Manual, battery, soft case
Optional Accessories	850027P Pt 1000Temp. probe

ELECTRICAL SPECIFICATIONS

($\pm 23 \pm 5^{\circ}\text{C}$)

Air Velocity			
Unit	Range	Res.	Acc.
ft/min	80 ~ 3927	1	$\leq 20 \text{ m/s} : \pm 3\% \text{ F.S.}$ $> 20 \text{ m/s} : \pm 4\% \text{ F.S.}$
m/s	0.4 ~ 20.0	0.1	
km/h	1.4 ~ 72.0	0.1	
mph	0.9 ~ 44.7	0.1	
knots	0.8 ~ 38.8	0.1	
Temp. $^{\circ}\text{C}/^{\circ}\text{F}$	0 ~ 50°C	0.1°C	$\pm 1.2^{\circ}\text{C}$
	32 ~ 122°F	0.1°F	$\pm 2.5^{\circ}\text{F}$

ft/min: feet per minute

mph: miles per hour

m/s: meters per second

knots: nautical miles

km/h: kilometers per hour

per hour

Air Flow		
Unit	Range	Res.
CMM	0.024 ~ 36000	0.001/0.01/0.1/1
CFM	0.847 ~ 1271300	0.001/0.01/0.1/1/10 (x10)/100 (x100)

ELECTRICAL SPECIFICATIONS

($\pm 23 \pm 5^{\circ}\text{C}$)

Wind chill			
Unit	Range	Res.	Acc.
$^{\circ}\text{C}$	$-0.4 \sim 44.2^{\circ}$	0.1°	$\pm 2.0^{\circ}\text{C}$
$^{\circ}\text{F}$	$15.0 \sim 112.0^{\circ}$	0.1°	$\pm 3.6^{\circ}\text{F}$

*Wind chill value is in effect only when the Temp. value $< 15^{\circ}\text{C}$ and Air velocity value $> 1.4 \text{ m/s}$.

Humidity/Temperature			
Unit	Range	Res.	Acc.
%RH	10 to 95 %RH	0.1 % RH	$< 70 \text{ %RH: } \pm 4 \text{ %RH}$ $\geq 70 \text{ %RH: } \pm (4\% \text{ rdg} + 1.2 \text{ %RH})$
Temp.	$0 \sim 50^{\circ}\text{C}$	0.1°C	$\pm 1.2^{\circ}\text{C}$
	$32 \sim 122^{\circ}\text{F}$	0.1°F	$\pm 2.5^{\circ}\text{F}$

Dew point Temp.			
Unit	Range	Res.	Remark
$^{\circ}\text{C}$	$-25.3 \sim 49.0^{\circ}$	0.1°	*Calculate from the humidity / Temp. value
$^{\circ}\text{F}$	$-13.5 \sim 120.0^{\circ}$	0.1°	

Wet bulb Temp.			
Unit	Range	Res.	Remark
$^{\circ}\text{C}$	$-5.4 \sim 49.0^{\circ}$	0.1°	*Calculate from the humidity / Temp. value
$^{\circ}\text{F}$	$22.2 \sim 120^{\circ}$	0.1°	

ELECTRICAL SPECIFICATIONS

($\pm 23 \pm 5^{\circ}\text{C}$)

Light *auto range			
Unit	Range	Res.	Acc.
Lux	0 ~ 2,200 Lux	1 Lux	$\pm 5\%$ rdg
	1,800 ~ 20,000 Lux	10 Lux	
Foot-candle	0 ~ 204.0 FC	0.1 FC	$\pm 8\%$ rdg
	170 ~ 1,860 FC	1 FC	

Barometric Pressure (Barometer)			
Unit	Range	Res.	Acc.
hPa	10.0 ~ 999.9	0.1 hpa	± 1.5 hPa
	1000 ~ 1100	1 hpa	± 2 hPa
mmHg	7.5 ~ 825.0	0.1 mmHg	± 1.2 mmHg
inHg	0.29 ~ 32.48	0.01 inHg	± 0.05 inHg

Altitude			
Unit	Range	Res.	Acc.
m	-2000 ~ 9000m	1 m	± 15 m
ft	-6000 ~ 30000 ft	1 ft	± 50 ft

ELECTRICAL SPECIFICATIONS

($\pm 23 \pm 5^{\circ}\text{C}$)

Pt 1000 Thermometer (opt. probe)			
Unit	Range	Res.	Acc.
$^{\circ}\text{C}$	-10.0 ~ 100.0	0.1 $^{\circ}\text{C}$	$\pm 1.2^{\circ}\text{C}$
$^{\circ}\text{F}$	14.0 ~ 212.0	0.1 $^{\circ}\text{F}$	$\pm 2.5^{\circ}\text{F}$

Heat index			
Unit	Range	Res.	Accuracy
$^{\circ}\text{C}$	0 ~ 100 $^{\circ}$	0.1 $^{\circ}$	$\pm 2.0^{\circ}\text{C}$
$^{\circ}\text{F}$	32 ~ 212 $^{\circ}$	0.1 $^{\circ}$	$\pm 3.6^{\circ}\text{F}$

Effects of the heat index (shade values)		
$^{\circ}\text{C}$	$^{\circ}\text{F}$	Notes
27~ 32 $^{\circ}$	80~ 90 $^{\circ}$	Caution: Fatigue is possible with prolonged exposure and activity. Continuing activity could result in heat cramps
32~ 41 $^{\circ}$	90~ 105 $^{\circ}$	Extreme caution: Heat cramps, and heat exhaustion are possible. Continuing activity could result in heat stroke
41~ 54 $^{\circ}$	105~ 130 $^{\circ}$	Danger: Heat cramps, and heat exhaustion are likely; heat stroke is probable with continued activity
54 $^{\circ}$ +	130 $^{\circ}$ +	Extreme danger: Heat stroke is imminent

*Exposure to full sunshine can increase heat index values by up to 8 $^{\circ}\text{C}$ (14 $^{\circ}\text{F}$)

WARRANTY

Sper Scientific warrants this product against defects in materials and workmanship for a period of **five (5) years** from the date of purchase, and agrees to repair or replace any defective unit without charge. If your model has since been discontinued, an equivalent Sper Scientific product will be substituted if available. This warranty does not cover probes, batteries, battery leakage, or damage resulting from accident, tampering, misuse, or abuse of the product. Opening the meter to expose its electronics will void the warranty.

To obtain warranty service, ship the unit postage prepaid to:

SPER SCIENTIFIC LTD.
8281 E. Evans Rd., Suite #103
Scottsdale, AZ 85260

The defective unit must be accompanied by a description of the problem and your return address. Register your product online at www.sperscientific.com, or return your warranty card within 10 days of purchase.